

BC3-M12-AP6X/S90/3GD 15M Capacitive Sensor

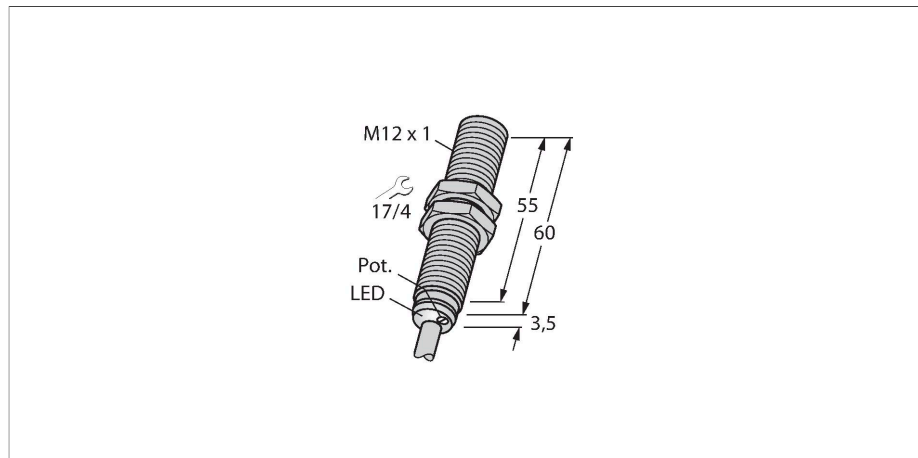

Features

- M12 × 1 threaded barrel
- Chrome-plated brass
- Fine adjustment via potentiometer
- DC 3-wire, 10...30 VDC
- NO contact, PNP output
- Cable connection
- ATEX category II 3 G, Ex zone 2
- ATEX category II 3 D, Ex zone 22

Wiring diagram

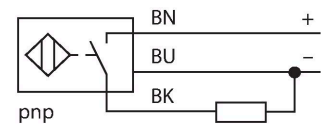

Technical data

Type	BC3-M12-AP6X/S90/3GD 15M
ID	2601004
Rated switching distance (flush)	3 mm
Rated switching distance (non-flush)	3 mm
Secured operating distance	≤ (0.72 × Sn)
Hysteresis	1...20 %
Temperature drift	Typical 20 %
Repeat accuracy	≤ 2 % of full scale
Ambient temperature	-25...+70 °C
For explosion hazardous areas see instruction leaflet	
Electrical data	
Operating voltage	10...30 VDC
Residual ripple	≤ 10 % U _{ss}
DC rated operational current	≤ 200 mA
No-load current	≤ 15 mA
Residual current	≤ 0.1 mA
Switching frequency	0.1 kHz
Oscillation frequency	According to EN 60947-5-2, 8.2.6.2 Table 9: 0.1...2.0 MHz
Isolation test voltage	≤ 0.5 kV
Output function	3-wire, NO contact, PNP
Short-circuit protection	yes / Cyclic
Voltage drop at I _o	≤ 1.8 V
Wire breakage/Reverse polarity protection	yes / Complete
Approval acc. to	ATEX declaration of conformity TURCK Ex-03025H X

Functional principle

Capacitive proximity switches are designed for non-contact and wear-free detection of electrically conductive as well as non-conductive metal objects.

Technical data

Device marking	Ex II 3 G Ex nA IIC T5 Gc / II 3 D Ex t IIIC T91°C Dc
Warning	Protect against mechanical damage
Mechanical data	
Design	Threaded barrel, M12 × 1
Dimensions	63.5 mm
Housing material	Metal, CuZn, Chrome-plated
Active area material	ABS
Admissible pressure on front cap	≤ 5 bar
Max. tightening torque of housing nut	10 Nm
Electrical connection	Cable
Cable quality	Ø 4 mm, LifYY-11Y, PUR, 15 m
Core cross-section	3 x 0.25 mm ²
Vibration resistance	55 Hz (1 mm)
Shock resistance	30 g (11 ms)
Protection class	IP67
MTTF	1080 years acc. to SN 29500 (Ed. 99) 40 °C
Switching state	LED, Yellow

Mounting instructions

Product features

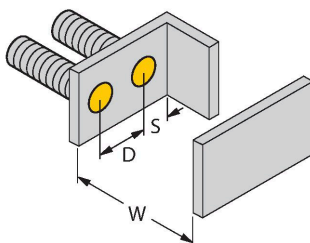
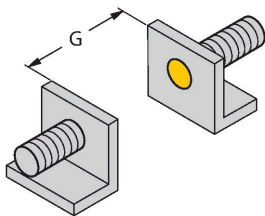

Distance D	24 mm
Distance W	9 mm
Distance S	18 mm
Distance G	18 mm
Diameter active area B	Ø 12 mm

The given minimum distances have been checked against the standard switching distance.
Should the sensitivity of the sensors be changed via potentiometer, the data sheet specifications no longer apply.

Accessories

MAP-M12-PP

6950016

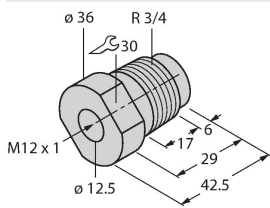

Mounting adapter; material: Polypropylene; sensor replacement with filled container possible (adapter remains in container during sensor replacement)

MAP-M12-PVDF

6950017

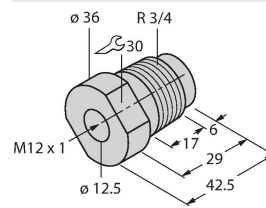

Mounting adapter; material: Polyvinylidenflourid; sensor can be replaced with filled container (adapter remains in container during replacement)

BST-12B

6947212

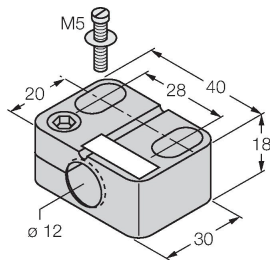

Mounting clamp for threaded barrel sensors, with dead-stop; material: PA6

Instructions for use

Intended use

This device fulfills the directive 2014/34/EC and is suited for use in explosion hazardous areas acc. to EN60079-0:2009, EN60079-15:2010 and EN60079-31:2009. In order to ensure correct operation to the intended purpose it is required to observe the national regulations and directives.

For use in explosion hazardous areas conform to classification

II 3 G and II 3 D (Group II, Category 3 G, electrical equipment for gaseous atmospheres and category 3 D, electrical equipment for dust atmospheres).

Marking (see device or technical data sheet)

Ex II 3 G and Ex nA IIC T5 Gc acc. to EN 60079-0:2009 and EN 60079-15:2010 and Ex II 3 D Ex t IIIC T91°C Dc acc. to EN 60079-0:2009 and EN 60079-31:2009

Installation/Commissioning

These devices may only be installed, connected and operated by trained and qualified staff. Qualified staff must have knowledge of protection classes, directives and regulations concerning electrical equipment designed for use in explosion hazardous areas. Please verify that the classification and the marking on the device comply with the actual application conditions.

Installation and mounting instructions

Avoid static charging of cables and plastic devices. Please only clean the device with a damp cloth. Do not install the device in a dust flow and avoid build-up of dust deposits on the device. If the devices and the cable could be subject to mechanical damage, they must be protected accordingly. They must also be shielded against strong electro-magnetic fields. The pin configuration and the electrical specifications can be taken from the device marking or the technical data sheet. In order to avoid contamination of the device, please remove possible blanking plugs of the cable glands or connectors only shortly before inserting the cable or opening the cable socket.

Special conditions for safe operation

Devices with terminal chamber (cable glands) have a weaker strain relief. Sufficient strain relief must be ensured or the cable must be stationary-mounted. Do not disconnect the plug-in connection or cable under voltage. Please attach a warning label permanently in an appropriate fashion in close proximity to the plug-in connection with the following inscription: Nicht unter Spannung trennen / Do not separate when energized. The device must be protected against any kind of mechanical damage and degrading UV-radiation. On selecting the approval-relevant accessories, always ensure that they are installed conform to the application. Load voltage and operating voltage of this equipment must be supplied from power supplies with safe isolation (IEC 30 364/UL508), to ensure that the rated voltage of the equipment (24 VDC +20% = 28.8 VDC) is never exceeded by more than 40%.

Service/Maintenance

Repairs are not possible. The approval expires if the device is repaired or modified by a person other than the manufacturer. The most important data from the approval are listed.